

CURRENT MODE PWM CONTROLLER

UC3842

Features

- Low Start up Current
- Maximum Duty Clamp
- UVLO With Hysteresis
- Operating Frequency up to 500KHz

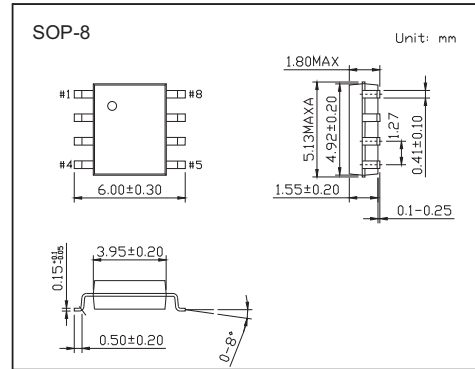

Functional Block Diagram

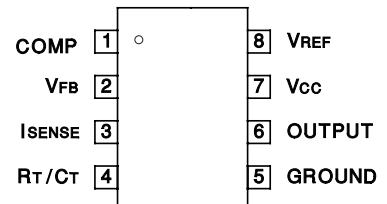
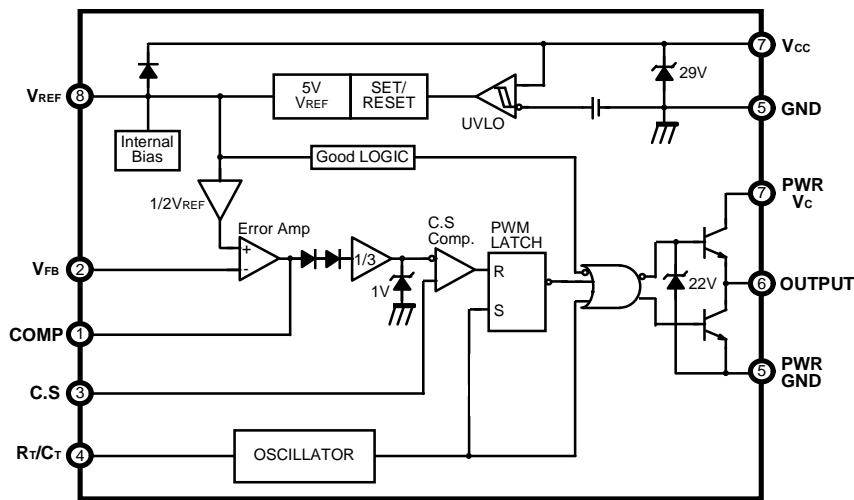

Absolute Maximum Ratings Ta = 25

Parameter	Symbol	Ratings	Units
Supply Voltage	V _{CC}	30	V
Output Current	I _O	± 1	A
Analog Inputs	V _(ANA)	-0.3 to 6.3	V
Error Amp Output Sink Current	I _{SINK (E.A)}	10	mA
Power Dissipation at TA 25	P _D (Note1,2)	460	mW
Storage Temperature Range	T _{STG}	-65 ~ +150	
Lead Temperature	T _{LEAD}	+300	
Thermal Resistance Junction-ambient	R _{thj-a}	125	/W

CURRENT MODE PWM CONTROLLER

UC3842

Electrical Characteristics ($V_{CC}=15V, R_T=10k, C_T=3.3nF, T_A=0$ to $+70$, unless otherwise specified)

Parameter	Symbol	Conditions	Min	Typ	Max	Unit
Reference Output Voltage	V_{REF}	$T_J = 25$, $I_{REF} = 1mA$	4.9	5.0	5.1	V
Line Regulation	V_{REF}	12V V_{CC} 25V		6	20	mV
Load Regulation	V_{REF}	1mA I_{REF} 20mA		6	25	mV
Short Circuit Output Current	I_{SC}	$T_A = 25$		-100	-180	mA
Oscillation Frequency	f	$T_J = 25$	47	52	57	kHz
Frequency Change with Voltage	f/V_{CC}	12V V_{CC} 25V		0.2	1	%
Oscillator Amplitude	V_{OSC}			1.7		VP-P
Input Bias Current	I_{BIAS}	CURRENT SENSE SECTION		-2	-10	μA
Input Voltage	$V_{I(E>A)}$	$V_{pin1} = 2.5V$	2.42	2.5	2.58	V
Open Loop Voltage Gain	G_{VO}	2V V_o 4V (Note3)	65	90		dB
Power Supply Rejection Ratio	$PSRR$	12V V_{CC} 25V (Note3)	60	70		dB
Output Sink Current	I_{SINK}	$V_{pin2} = 2.7V, V_{pin1} = 1.1V$	2	70		mA
Output Source Current	I_{SOURCE}	$V_{pin2} = 2.3V, V_{pin1} = 5V$	-0.6	-1.0		mA
High Output Voltage	V_{OH}	$V_{pin2} = 2.3V, R_L = 15k$ to GND	5	6		V
Low Output Voltage	V_{OL}	$V_{pin2} = 2.7V, R_L = 15k$ to Pin 8		0.7	1.1	V
Gain	G_V	(Note 1 & 2)	2.85	3	3.15	V/V
Maximum Input Signal	$V_{I(MAX)}$	$V_{pin1} = 5V$ (Note 1)	0.9	1	1.1	V
Power Supply Rejection Ratio	$PSRR$	12V V_{CC} 25V (Note 1,3)		70		dB
Input Bias Current	I_{BIAS}	ERROR AMPLIFIER SECTION		-0.3	-2	μA
Low Output Voltage	V_{OL}	$I_{SINK} = 20mA$		0.1	0.4	V
		$I_{SINK} = 200mA$		1.5	2.2	V
High Output Voltage	V_{OH}	$I_{SOURCE} = 20mA$	13	13.5		V
		$I_{SOURCE} = 200mA$	12	13.5		V
Rise Time	t_R	$T_J = 25$, $C_L = 1nF$ (Note 3)		40	100	ns
Fall Time	t_F	$T_J = 25$, $C_L = 1nF$ (Note 3)		40	100	ns
Start Threshold	$V_{TH(ST)}$		15	16	17	V
Min. Operating Voltage (After Turn On)	$V_{OPR(MIN)}$		9	10	11	V
Max. Duty Cycle	$D_{(Max)}$		94	96	100	%
Min. Duty Cycle	$D_{(MIN)}$				0	%
Start-Up Current	I_{ST}			0.2	0.4	mA
Operating Supply Current	$I_{CC(OPR)}$	$V_{pin3}=V_{pin2}=ON$		11	17	mA
Zener Voltage	V_Z	$I_{CC} = 25mA$		29		V

Adjust VCC above the start threshold before setting at 15V

Note:

1. Parameter measured at trip point of latch
2. Gain defined as:

$$A = \frac{\Delta V_{pin1}}{\Delta V_{pin3}}, 0 \leq V_{pin3} \leq 0.8V$$

3. These parameters, although guaranteed, are not 100 tested in production.

UC3842

■ Typical Characteristics

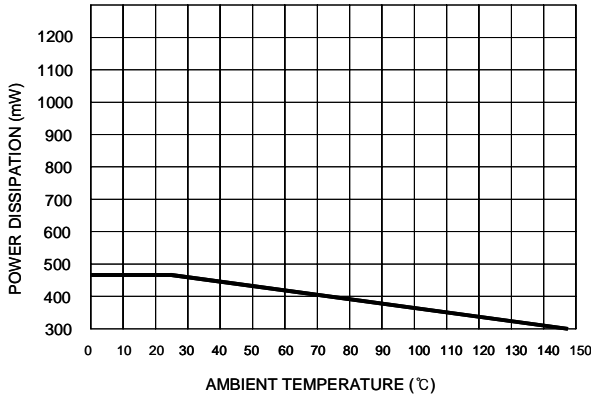

Figure 1. Power Dissipation Curve

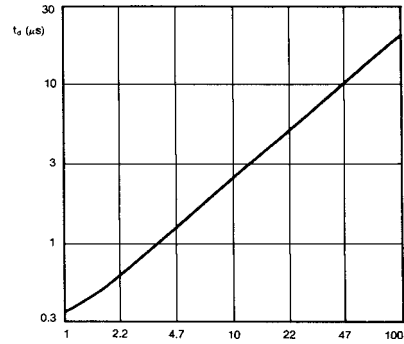

Figure 2. Oscillator Dead Time & Frequency

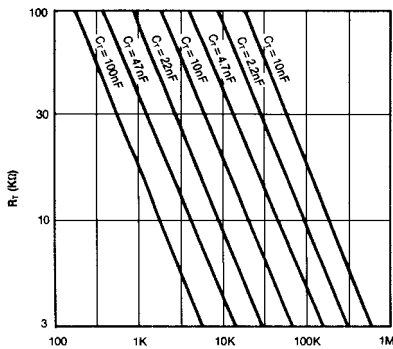

Figure 3. Timing Resistance vs Frequency

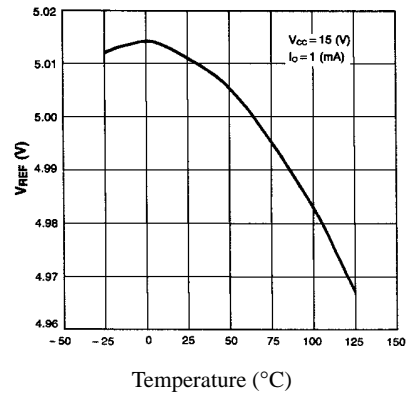

Figure 4. Temperature Drift (Vref)

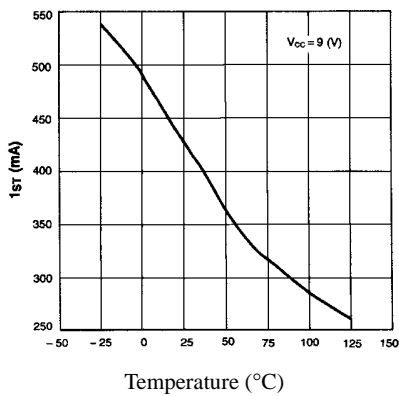

Figure 5. Temperature Drift (Ist)

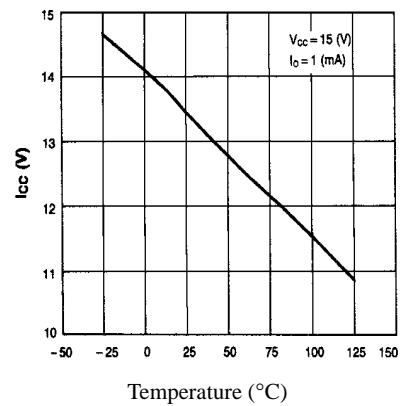

Figure 6. Temperature Drift (Icc)