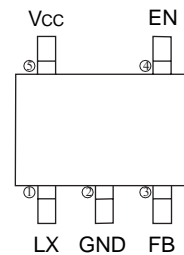
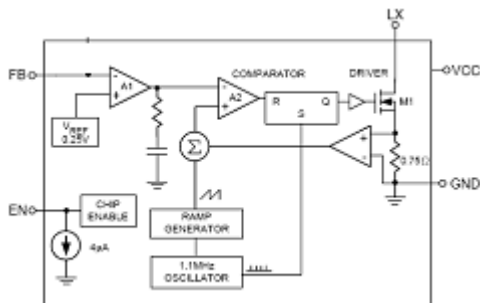
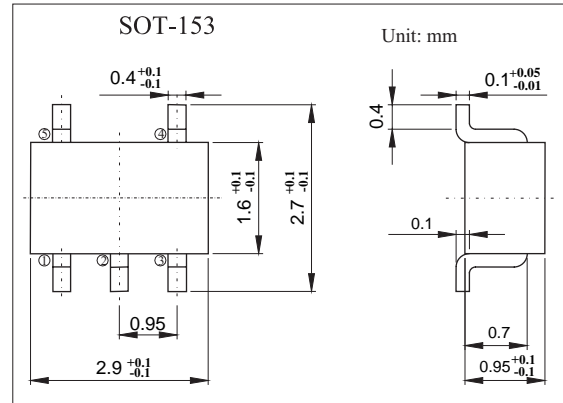

1.0MHz Current-Mode Step-Up DC/DC Converter

RCR2561

■ Features

- Inherently Matched LED Current
- Up to 80mA Output Current @ $V_{OUT} < 20V$
- High Efficiency: 85% Typical
- Drives Up to Three LEDs from 2.8V Supply
- 20V Internal Switch
- Fast 1.1 MHz Switching Frequency
- Uses Tiny 1 mm Height Inductors
- Requires Only 1uF Output Capacitor
- Optional 15V Over Voltage Protection

■ Absolute Maximum Ratings $T_a = 25^\circ\text{C}$

Parameter	Symbol	Rating	Unit
Power Supply Voltage	V_{CC}	-0.3 to +7	V
LX Pin Voltage	V_{LX}	-0.3 to +21	V
The Other Pins Voltage		-0.3 to +7	V
Power Dissipation @ $T_A = 25^\circ\text{C}$	P_D	400	mW
Thermal Resistance	$R_{\theta JA}$	250	$^\circ\text{C}/\text{W}$
Operating Junction Temperature	T_J	125	$^\circ\text{C}$
Storage Temperature Range	T_{stg}	-65 to +150	$^\circ\text{C}$
HBM (Human Body Mode) (Note 1)		2	KV
MM (Machine Mode) (Note 1)		200	V

RCR2561

■ Electrical Characteristics ($V_{in}=V_{SHDN}=3.0V, T_a = 25^{\circ}C$)

Parameter	Symbol	Test conditons	Min	Typ	Max	Unit
System Supply Input						
Under Voltage Lock Out	UVLO	$V_{Pin 5} = 0 V, C_T = 1.0 nF, T_A = 25^{\circ}C$	2.4	2.5	2.6	V
Maximum Output Voltage	V_o				20	V
Supply Current	I_{CC1}	$V_{CC}=6V$ Continuously Switching			2	mA
Quiescent Current	I_{CC2}	$V_{CC}=6V, FB=1.3V$, No Switching	50	90	120	μA
Shut Down Current	I_{CC3}	$V_{CC}=6V, V_{EN}<0.4V$		0.1	1	μA
Oscillator						
Operation Frequency	F_{OSC}		0.9	1	1.1	MHz
Maximum Duty Cycle	D_{max}		85	90		%
Reference Voltage						
Feedback Voltage	V_{FB}		0.090	0.098	0.105	V
FB Input Bias current	I_{FB}	$V_{FB}=0.09V$		20	80	nA
MOSFET						
On Resistance of MOSFET	$R_{ds(on)}$		0.5	0.75	1.0	Ω
Current Limit	I_{max1}	Normal Operation	800	900	1000	mA
Current Limit	I_{max2}	Start up Condition	500	625	750	mA
Control and Protection						
Shut Down Voltage					0.4	V
Enable Voltage			1.4			V
EN Pin Pull Low Current				4	6	μA

Note: 1. Devices are ESD sensitive. Handling precaution recommended.

2. $R_{\theta JA}$ is measured in the natural convection at $T_A = 25^{\circ}C$ on a low effective thermal conductivity test board of JEDEC 51-3 thermal measurement standard.

■ Marking

Marking	RCR2561
---------	---------

RCR2561

■ Typical Application Circuit

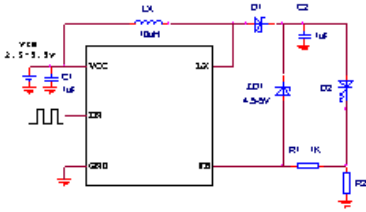

Figure 1. RCR2561 Drivers 1 WLED Application Circuit

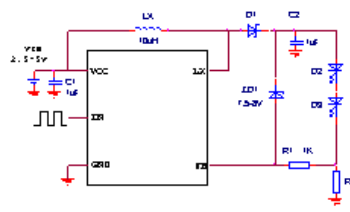

Figure 2. RCR2561 Drivers 2 Series WLEDs Application Circuit

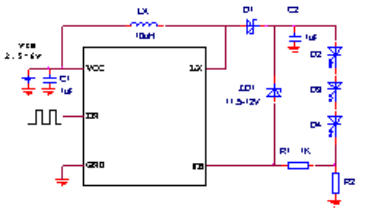

Figure 3. RCR2561 Drivers 3 Series WLEDs Application Circuit

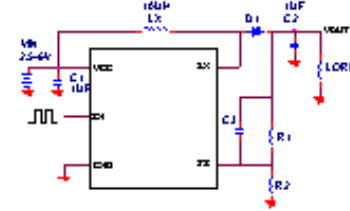

Figure 4. RCR2561 Drivers 4 Series WLEDs Application Circuit

$$V_{OUT} = ((R1+R2) / R2) * V_{FB}$$

$$V_{OUT \text{ LOW LIMIT}} = V_{IN}$$

$$V_{OUT \text{ HIGH LIMIT}} = 20V$$