

## NPN Surface Mount Darlingtion Transistor MMSTA13

### ■ Features

- Epitaxial Planar Die Construction
- Ideal for Medium Power Amplification and Switching
- High Current Gain

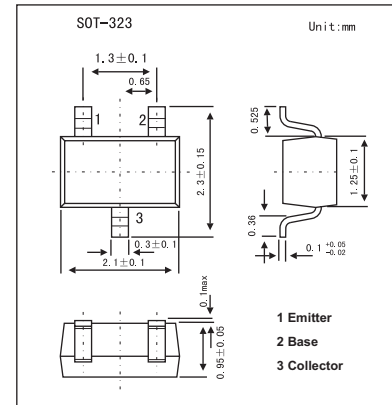
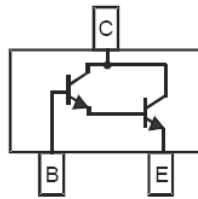

### ■ Absolute Maximum Ratings $T_a = 25^\circ\text{C}$

Parameter	Symbol	Rating	Unit
Collector-Base Voltage	$V_{CB0}$	30	V
Collector-Emitter Voltage	$V_{CE0}$	30	V
Emitter-Base Voltage	$V_{EB0}$	10	V
Collector Current	$I_c$	300	mA
Power Dissipation	$P_d$	200	mW
Thermal Resistance, Junction to Ambient	$R_{\theta JA}$	625	$^\circ\text{C}/\text{W}$
Operating and Storage and Temperature Range	$T_j, T_{STG}$	-55 to +150	$^\circ\text{C}$

### ■ Electrical Characteristics $T_a = 25^\circ\text{C}$

Parameter	Symbol	Testconditons	Min	Typ	Max	Unit
Collector-Base Breakdown Voltage	$V_{CB0}$	$I_c = 100 \mu\text{A}, I_E = 0$	30			V
Collector Cutoff Current	$I_{CBO}$	$V_{CB} = 30\text{V}, I_E = 0$			100	nA
Collector Cutoff Current	$I_{EBO}$	$V_{CE} = 10\text{V}, I_c = 0$			100	nA
DC Current Gain	$h_{FE}$	$I_c = 10\text{mA}, V_{CE} = 5\text{V}$	5,000			
		$I_c = 100\text{mA}, V_{CE} = 5\text{V}$	10,000			
Collector-Emitter Saturation Voltage	$V_{CE(sat)}$	$I_c = 100\text{mA}, I_B = 100 \mu\text{A}$			1.5	V
Base-Emitter Saturation Voltage	$V_{BE(sat)}$	$I_c = 100\text{mA}, V_{CE} = 5.0\text{V}$			2.0	V
Output Capacitance	$C_{ob0}$	$V_{CB} = 10\text{V}, f = 1.0\text{MHz}, I_E = 0$		8.1		pF
Input Capacitance	$C_{ib0}$	$V_{EB} = 0.5\text{V}, f = 1.0\text{MHz}, I_c = 0$		15		pF
Current Gain-Bandwidth Product	$f_T$	$V_{CE} = 5.0\text{V}, I_c = 10\text{mA}, f = 100\text{MHz}$	125			MHz

### ■ Marking

Marking	K2D

### MMSTA13

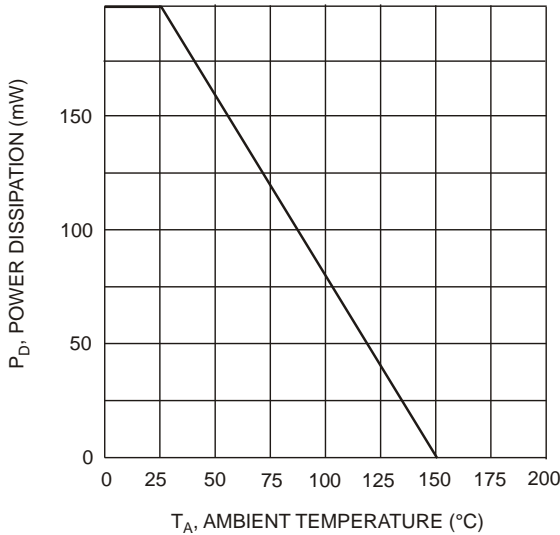

$T_A$ , AMBIENT TEMPERATURE (°C)  
Fig. 1, Max Power Dissipation vs Ambient Temperature

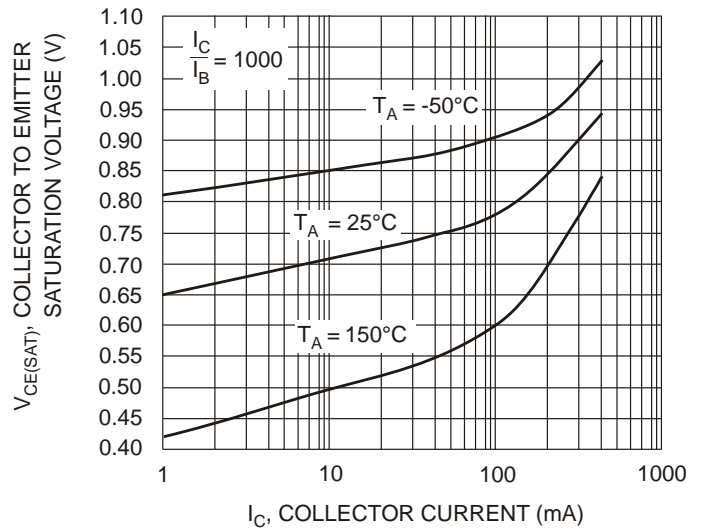

$I_C$ , COLLECTOR CURRENT (mA)  
Fig. 2, Collector Emitter Saturation Voltage vs. Collector Current

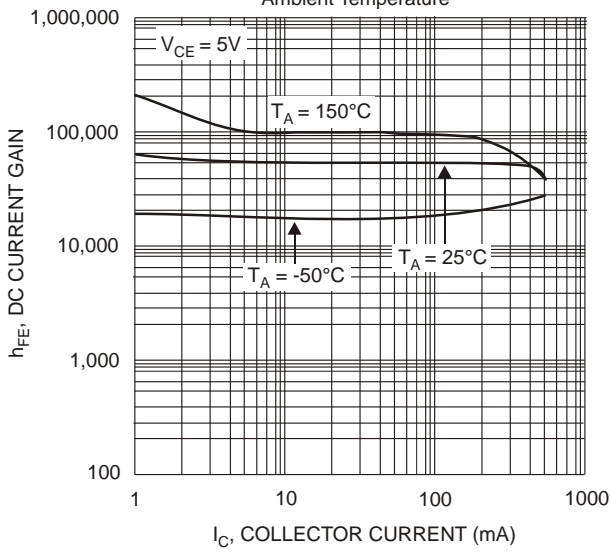

$I_C$ , COLLECTOR CURRENT (mA)  
Fig. 3, DC Current Gain vs Collector Current

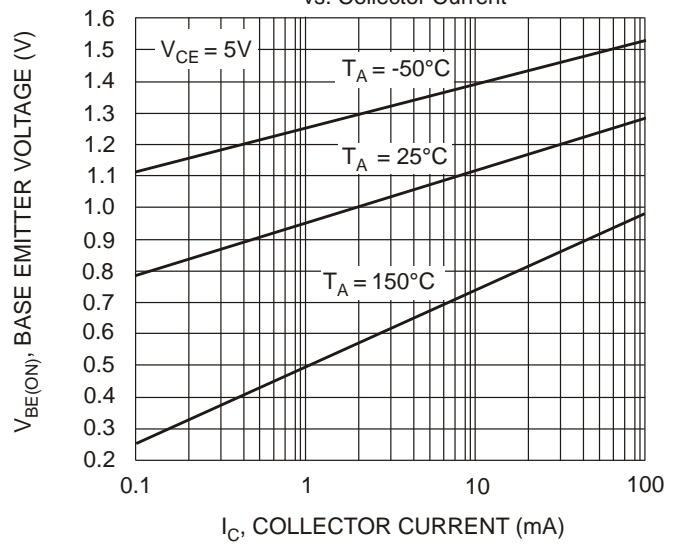

$I_C$ , COLLECTOR CURRENT (mA)  
Fig. 4, Base Emitter Voltage vs. Collector Current

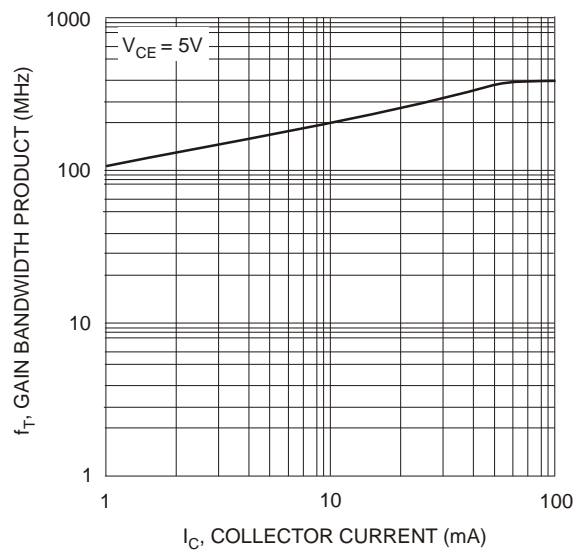
**MMSTA13**

$I_C$ , COLLECTOR CURRENT (mA)  
Fig. 5, Gain Bandwidth Product  
vs Collector Current