

Single Supply Dual Operational Amplifiers

KM358

■ Features

- Short Circuit Protected Outputs
- True Differential Input Stage
- Single Supply Operation: 3.0 V to 32 V
- Low Input Bias Currents
- Internally Compensated
- Common Mode Range Extends to Negative Supply
- Single and Split Supply Operation

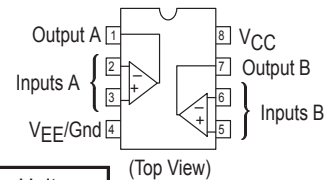
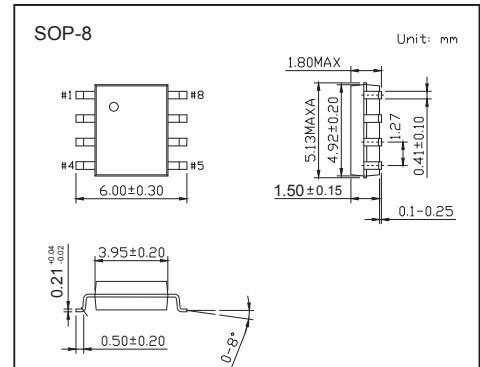

■ Absolute Maximum Ratings $T_a = 25^\circ\text{C}$

Parameter	Symbol	Rating	Unit
Power Supply Voltages			
Single Supply	V_{CC}	32	Vdc
Split Supplies	V_{CC}, V_{EE}	± 16	
Input Differential Voltage Range *1	V_{IDR}	± 32	Vdc
Input Common Mode Voltage Range *2	V_{ICR}	-0.3 to 32	Vdc
Output Short Circuit Duration	tsc	Continuous	
Junction Temperature	T_J	150	$^\circ\text{C}$
Thermal Resistance, Junction-to-Air	$R_{\theta JA}$	238	$^\circ\text{C/W}$
Storage Temperature Range	T_{stg}	-55 to +125	$^\circ\text{C}$
Operating Ambient Temperature Range	T_A	0 to +70	$^\circ\text{C}$

*1 Split Power Supplies.

*2 For supply voltages less than 32 V the absolute maximum input voltage is equal to the supply voltage.

■ Representative Schematic Diagram (One-Half of Circuit Shown)

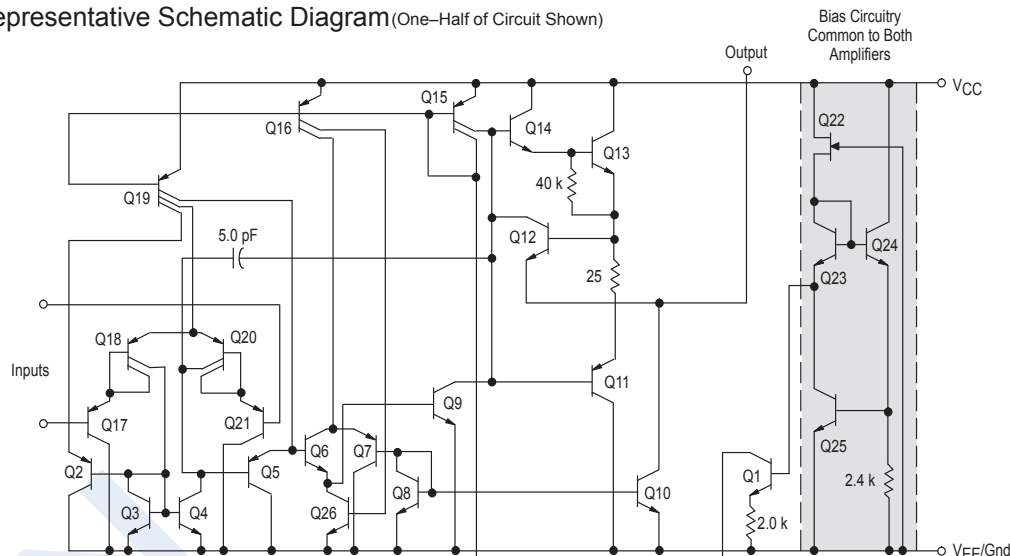

KM358

■ Electrical Characteristics $T_a = 25^\circ\text{C}$ ($V_{CC} = 5.0\text{ V}$, $V_{EE} = \text{Gnd}$, $T_a = 25^\circ\text{C}$, unless otherwise noted.)

Parameter	Symbol	Test conditions	Min	Typ	Max	Unit
Input Offset Voltage	V_{IO}	$V_{CC} = 5.0\text{ V}$ to 30 V , $V_{IC} = 0\text{ V}$ to $V_{CC} - 1.7\text{ V}$ $V_O \approx 1.4\text{ V}$, $R_S = 0\Omega$ $T_A = 25^\circ\text{C}$		2.0	7.0	mV
		$T_A = T_{High} *5$			9.0	
		$T_A = T_{Low} *5$			9.0	
Average Temperature Coefficient of Input Offset Voltage	$\Delta V_{IO}/\Delta T$	$T_A = T_{High}$ to $T_{Low} *5$		7.0		$\mu\text{V}/^\circ\text{C}$
Input Offset Current	I_{IO}	$T_A = T_{High}$ to $T_{Low} *5$		5.0	50	nA
					150	
Input Bias Current	I_{IB}	$T_A = T_{High}$ to $T_{Low} *5$		-45	-250	nA
				-50	-500	
Average Temperature Coefficient of Input Offset Current	$\Delta I_{IO}/\Delta T$	$T_A = T_{High}$ to $T_{Low} *5$		10		$\text{pA}/^\circ\text{C}$
Input Common Mode Voltage Range *6	V_{ICR}	$V_{CC} = 30\text{ V}$	0		28.3	V
		$V_{CC} = 30\text{ V}$, $T_A = T_{High}$ to T_{Low}	0		28	
Differential Input Voltage Range	V_{IDR}				V_{CC}	V
Large Signal Open Loop Voltage Gain	A_{VOL}	$R_L = 2.0\text{ k}\Omega$, $V_{CC} = 15\text{ V}$, For Large V_O Swing, $T_A = T_{High}$ to T_{Low}	25	100		V/mV
			15			
Channel Separation	C_s	$1.0\text{ kHz} \leq f \leq 20\text{ kHz}$, Input Referenced		-120		dB
Common Mode Rejection	CMR	$R_S \leq 10\text{ k}\Omega$	65	70		dB
Power Supply Rejection	PSR		65	100		dB
Output Voltage-High Limit	V_{OH}	$T_A = T_{High}$ to $T_{Low} *5$ $V_{CC} = 5.0\text{ V}$, $R_L = 2.0\text{ k}\Omega$, $T_A = 25^\circ\text{C}$ $V_{CC} = 30\text{ V}$, $R_L = 2.0\text{ k}\Omega$ $V_{CC} = 30\text{ V}$, $R_L = 10\text{ k}\Omega$	3.3	3.5		V
			26			
			27	28		
Output Voltage-Low Limit	V_{OL}	$V_{CC} = 5.0\text{ V}$, $R_L = 10\text{ k}\Omega$ $T_A = T_{High}$ to $T_{Low} *5$		5	20	mV
Output Source Current	I_{O+}	$V_{ID} = +1.0\text{ V}$, $V_{CC} = 15\text{ V}$	20	40		mA
Output Sink Current	I_{O-}	$V_{ID} = -1.0\text{ V}$, $V_{CC} = 15\text{ V}$	10	20		mA
		$V_{ID} = -1.0\text{ V}$, $V_O = 200\text{ mV}$	12	50		μA
Output Short Circuit to Ground *7	I_{SC}			40	60	mA
Power Supply Current (Total Device)	I_{CC}	$T_A = T_{High}$ to $T_{Low} *5$ $V_{CC} = 30\text{ V}$, $V_O = 0\text{ V}$, $R_L = \infty$ $V_{CC} = 5\text{ V}$, $V_O = 0\text{ V}$, $R_L = \infty$		1.5	3.0	mA
				0.7	1.2	

*5 $T_{Low} = 0^\circ\text{C}$, $T_{High} = +70^\circ\text{C}$ *6 The input common mode voltage or either input signal voltage should not be allowed to go negative by more than 0.3 V.
The upper end of the common mode voltage range is $V_{CC} - 1.7\text{ V}$.*7 Short circuits from the output to VCC can cause excessive heating and eventual destruction.
Destructive dissipation can result from simultaneous shorts on all amplifiers.

■ Marking

Marking	358
---------	-----

KM358

Typical Characteristics

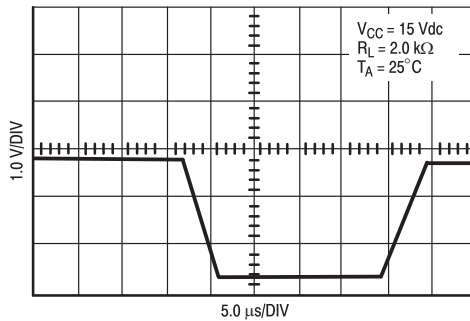

Figure 1. Large Signal Voltage Follower Response

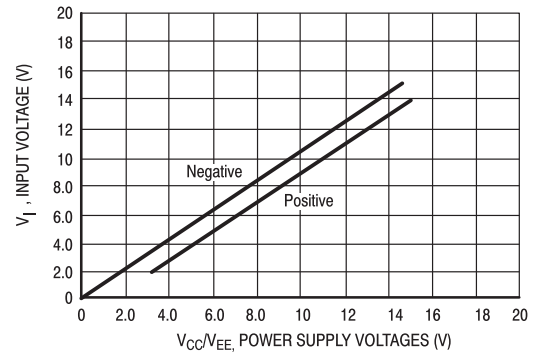

Figure 2. Input Voltage Range

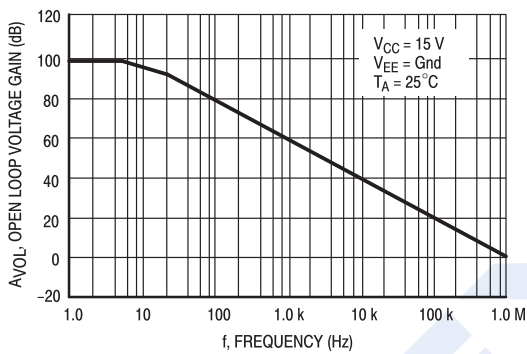

Figure 3. Large-Signal Open Loop Voltage Gain

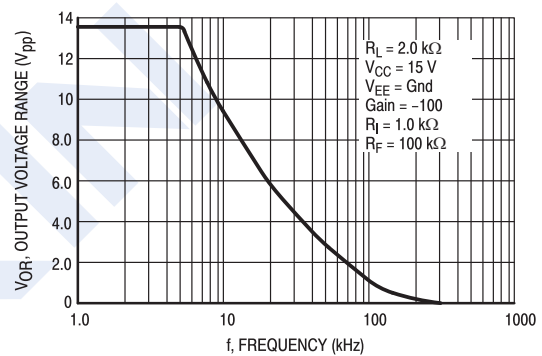

Figure 4. Large-Signal Frequency Response

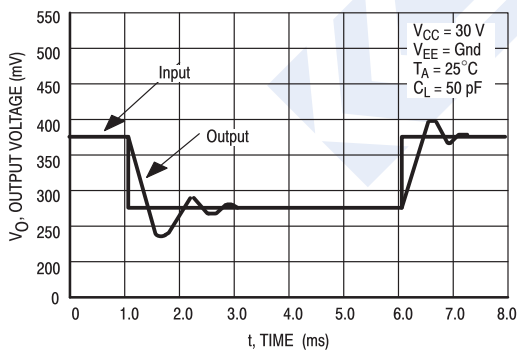

Figure 5. Small Signal Voltage Follower Pulse Response (Noninverting)

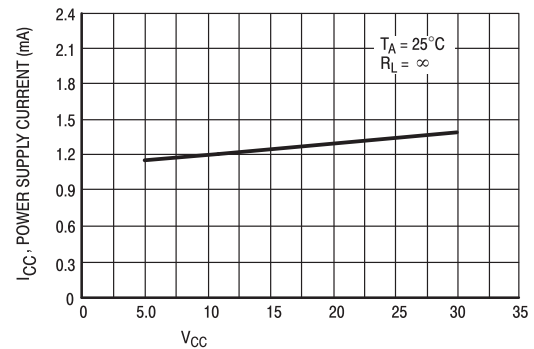

Figure 6. Power Supply Current versus Power Supply Voltage

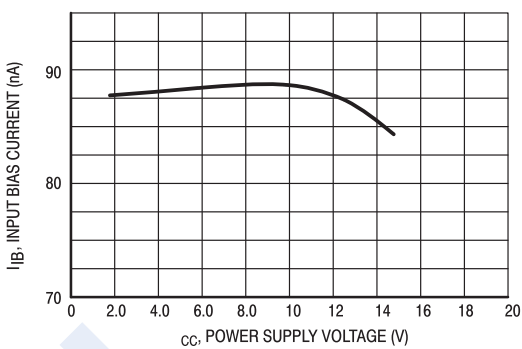

Figure 7. Input Bias Current versus Supply Voltage