

Three-Terminal Positive Voltage Regulator 78L05

■ Features

- Maximum output current: $I_{OM}=0.1A$.
- Output voltage: $V_o=5V$.
- Continuous total dissipation: $P_D: 0.625 W$ ($T_a=25^\circ C$)

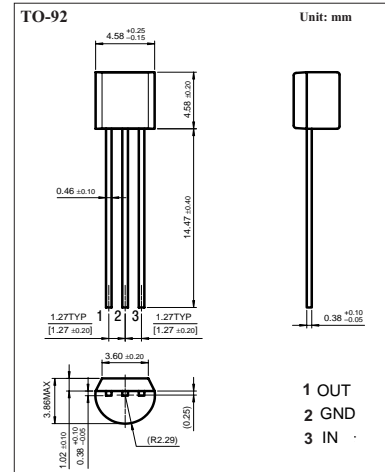

■ Absolute Maximum Ratings $T_a = 25^\circ C$

Parameter	Symbol	Rating	Unit
Input Voltage	V_I	30	V
Operating junction temperature range	T_{OPR}	0 to +125	$^\circ C$
Storage Temperature Range	T_{STG}	-55 to +150	$^\circ C$

■ Electrical Characteristics ($V_I=10V, I_o=40mA, 0^\circ C < T_j < 125^\circ C, C_1=0.33 \mu F, C_o=0.1 \mu F$, unless otherwise specified)

Parameter	Symbol	Testconditions	Min	Typ	Max	Unit
Output voltage	V_o	$T_j=25^\circ C$	4.8	5.0	5.2	V
		$7V \leq V_I \leq 20V, I_o=1mA-40mA$	4.75	5.0	5.25	V
		$I_o=1mA-70mA$	4.75	5.0	5.25	V
Load regulation	ΔV_o	$T_j=25^\circ C, I_o=1mA-100mA$		15	60	mV
		$T_j=25^\circ C, I_o=1mA-40mA$		8	30	mV
Line regulation	ΔV_o	$7V \leq V_I \leq 20V, T_j=25^\circ C$		32	150	mV
		$8V \leq V_I \leq 20V, T_j=25^\circ C$		26	100	mV
Quiescent current	I_q	$T_j=25^\circ C$		3.8	6	mA
Quiescent current change	ΔI_q	$0^\circ C < T_j < 125^\circ C, 8V \leq V_I \leq 20V$			1.5	mA
		$0^\circ C < T_j < 125^\circ C, 1mA \leq I_o \leq 40mA$			0.1	mA
Output noise voltage	V_N	$10Hz \leq f \leq 100KHz$		42		μV
Ripple rejection	RR	$8V \leq V_I \leq 20V, f=120Hz, T_j=25^\circ C$	41	49		dB
Dropout voltage	V_d	$T_j=25^\circ C$		1.7		V

■ Typical Application

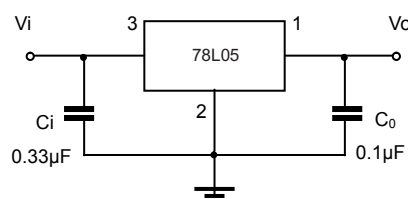

78L05

■ Typical Characteristics

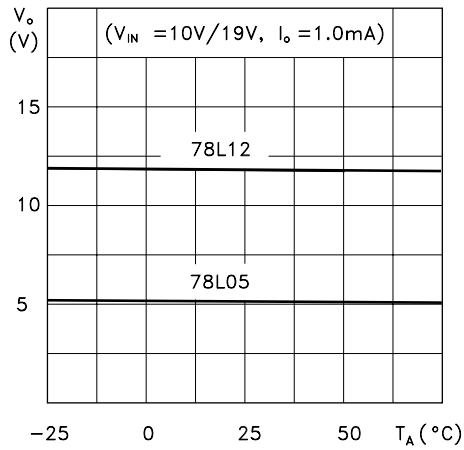

Figure 1 : Output Voltage vs Ambient Temperature

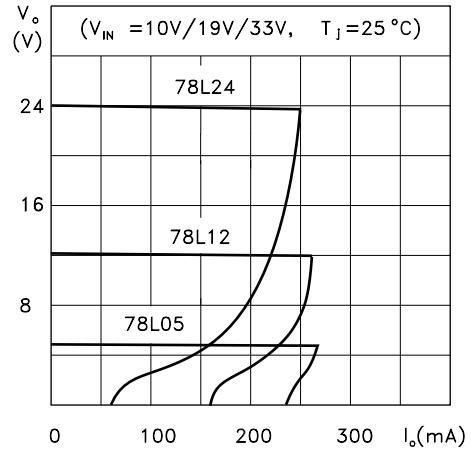

Figure 2 : Load Characteristics

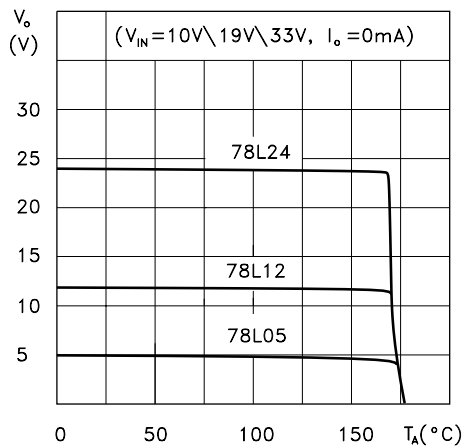

Figure 3 : Thermal Shutdown

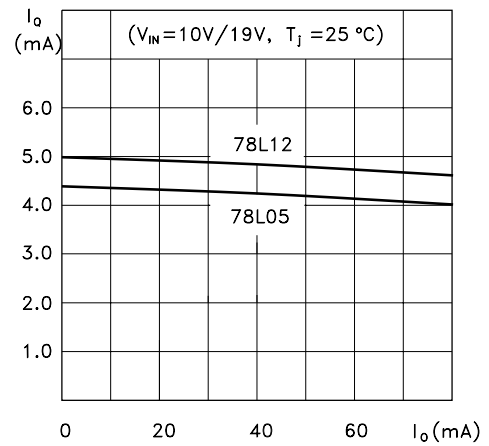

Figure 4 : Quiescent Current vs Output Current

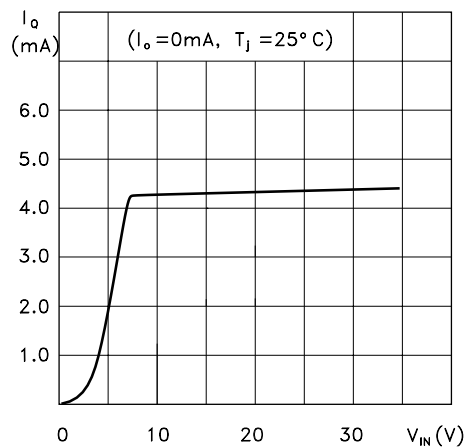

Figure 5 : Quiescent Current vs Input Voltage

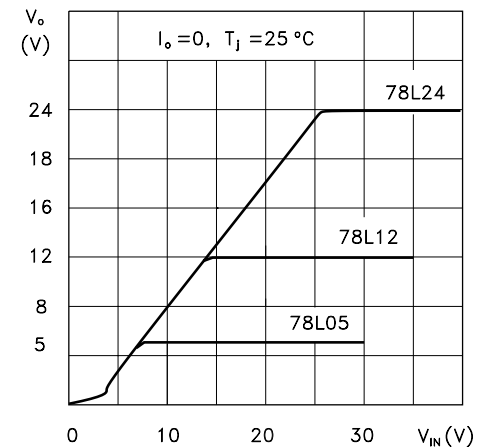

Figure 6 : Output Characteristics

78L05

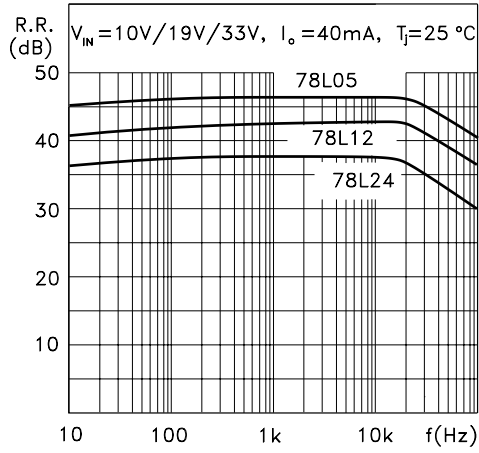

Figure 7 : RippleRejection

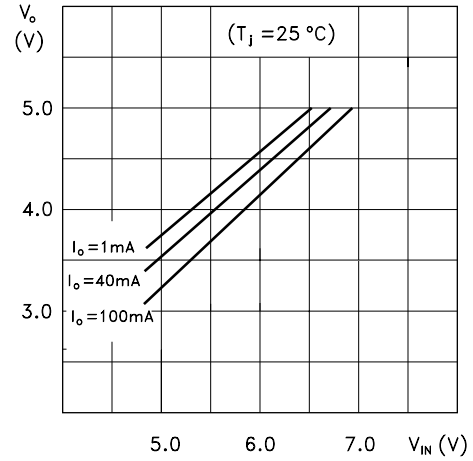

Figure 8 : DropoutCharacteristics

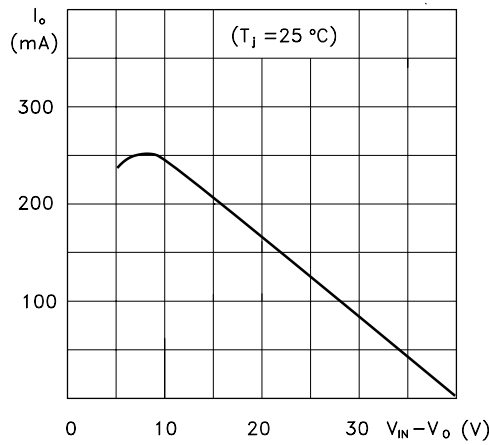

Figure 9 : ShortCircuitOutput Current