

NPN Surf Mount Transistor

DCP55-16-13

Features

- Epitaxial Planar Die Construction
- Complementary PNP Type Available (DCP52)
- Ideally Suited for Automated Assembly Processes
- Ideal for Medium Power Switching or Amplification Applications

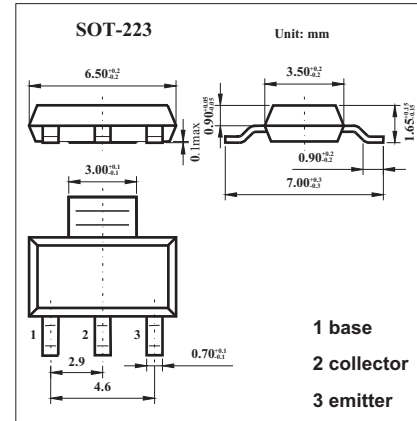

Absolute Maximum Ratings $T_a = 25$

Parameter	Symbol	Rating	Unit
collector-base voltage	V_{CB0}	60	V
collector-emitter voltage	V_{CE0}	60	V
emitter-base voltage	V_{EB0}	5	V
collector current (DC)	I_C	1	A
peak collector current ($t_P < 5ms$)	I_{CM}	1.5	A
power dissipation	P_D	1	W
thermal resistance from junction to ambient	R_{JA}	125	/W
junction temperature	T_j	150	
storage temperature	T_{stg}	-55 to +150	

Electrical Characteristics $T_a = 25$

Parameter	Symbol	Testconditions	Min	Typ	Max	Unit
Collector-base breakdown voltage	$V_{(BR)CBO}$	$I_C = 0.1mA, I_E = 0$	60			V
Collector-emitter breakdown voltage	$V_{(BR)CEO}$	$I_C = 10mA, I_B = 0$	60			
Base-emitter breakdown voltage	$V_{(BR)EBO}$	$I_C = 10\mu A, I_E = 0$	5			
Collector cut-off current	I_{CBO}	$I_E = 0 A; V_{CB} = 30 V$			100	nA
Emitter cut-off current	I_{EBO}	$I_C = 0 A; V_{EB} = 5 V$			10	μA
Collector-emitter saturation voltage	$V_{CE(sat)}$	$I_C = 500mA; I_B = 50 mA$			0.5	V
Base-Emitter Turn-On Voltage	$V_{BE(ON)}$	$I_C = 500mA; V_{CE} = 2V$			1.0	
DC current gain	h_{FE}	$I_C = 150 mA; V_{CE} = 2 V$	40		250	
		$I_C = 500 mA; V_{CE} = 2 V$	25			
		$I_C = 500 mA; V_{CE} = 2 V$	100		250	
Transition frequency	f_T	$I_C = 50 mA; V_{CE} = 5 V; f = 100 MHz$		200		MHz

DCP55-16-13

Typical Characteristics

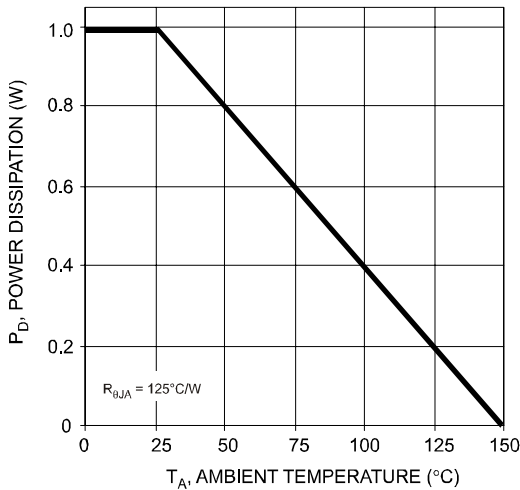

Fig. 1 Power Dissipation vs. Ambient Temperature

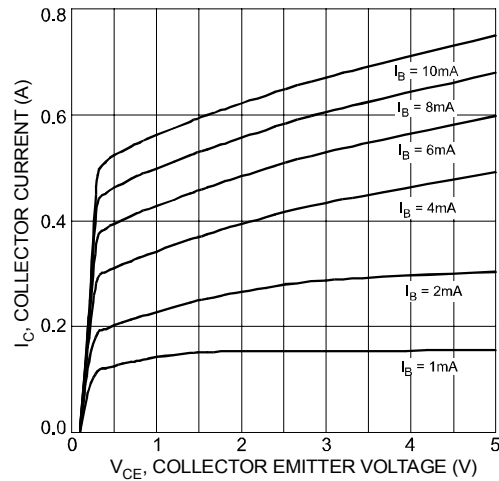

Fig. 2 Typical Collector Current vs. Collector Emitter Voltage

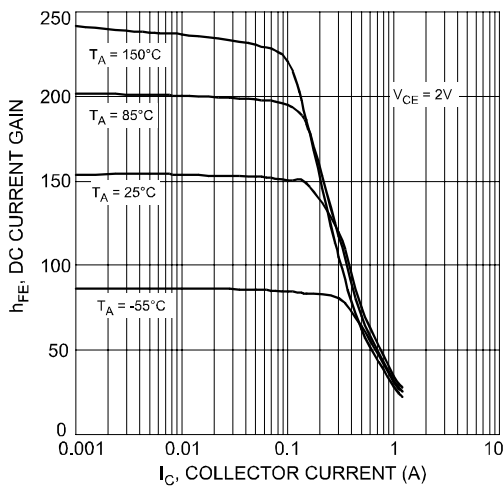

Fig. 3 Typical DC Current Gain vs. Collector Current

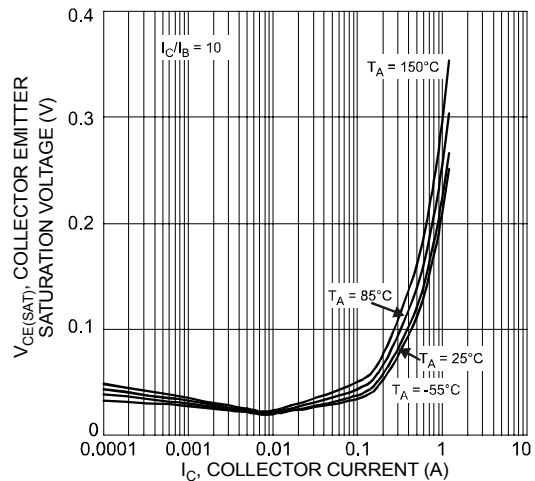

Fig. 4 Typical Collector Emitter Saturation Voltage vs. Collector Current

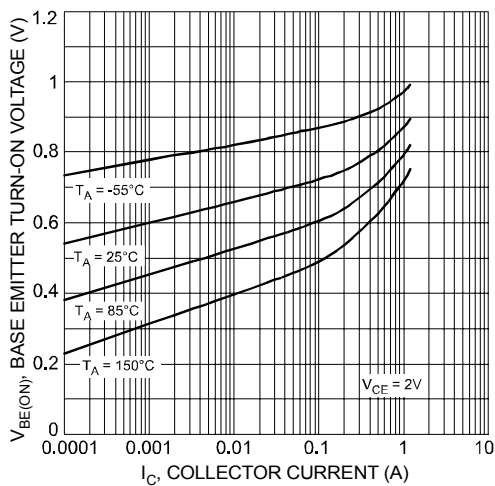

Fig. 5 Typical Base Emitter Turn-On Voltage vs. Collector Current

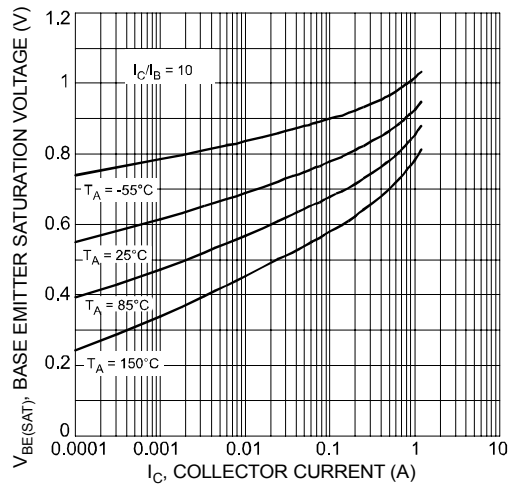

Fig. 6 Typical Base Emitter Saturation Voltage vs. Collector Current

DCP55-16-13

■ Typical Characteristics

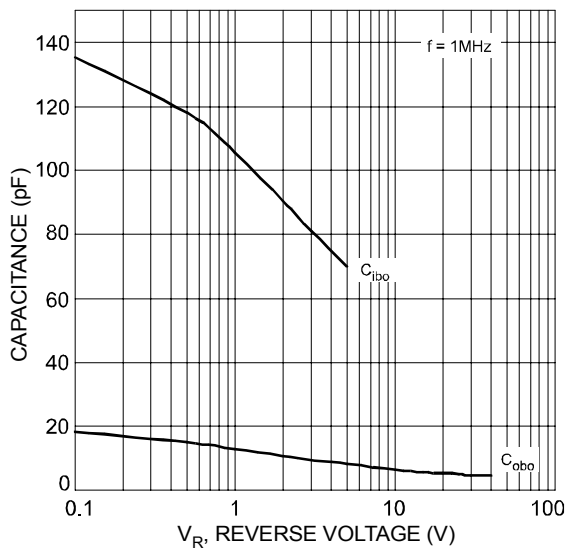

Fig. 7 Typical Capacitance Characteristics

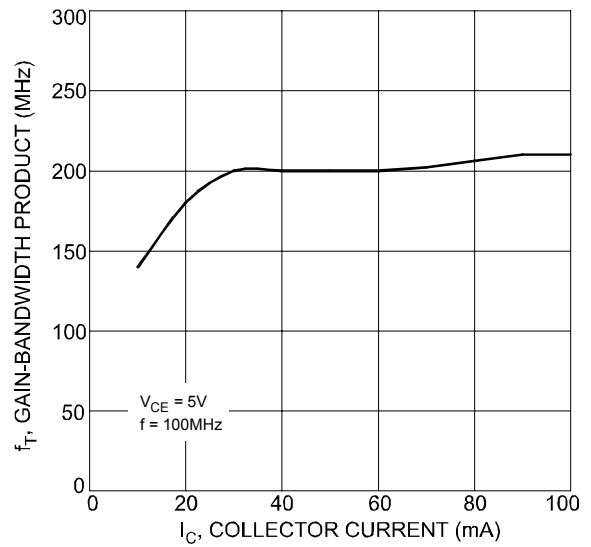

Fig. 8 Typical Gain-Bandwidth Product vs. Collector Current